

Strut / Channel

#ExStockNewcastle

- Sizes: 41x41, 41x21, 61x41
- Styles: Solid, Slotted, Ribbed, Double Sided
- Finishes: Hot Dip Galvanised, Pre-Galvanised, Stainless Steel, Milled & Fibre Reinforced Plastic

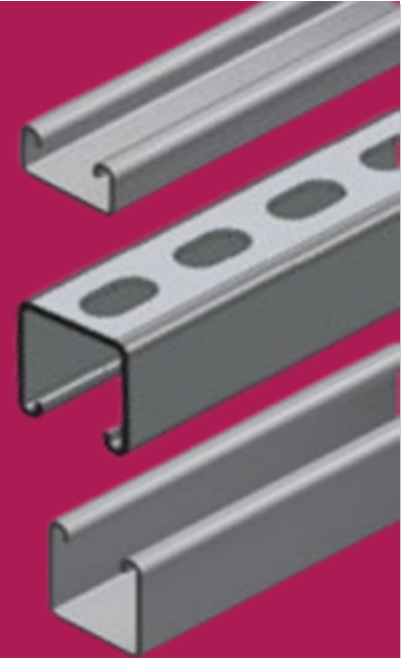

www.madisonexpress.com.au



FACEBOOK



INSTAGRAM

RJAN WEBSITE PORTAL

Do you want the ability to...

CHECK STOCKED ITEMS 

























LOOK UP PRICING 

DOWNLOAD DATASHEETS 

Contact us to set up a...

BRANCH LOG-IN

| | | | | | | | |
|------|------------------------------|------|---------------|------|-----|------|-----|
| J1 | COLIN O'BRIEN | RD07 | TODD HUGHES | RD14 | TBA | RD21 | TBA |
| J2 | B&R ENCLOSURES | RD08 | JULIAN NISBET | RD15 | TBA | RD22 | TBA |
| J3 | CABLEDUST SYSTEM | RD09 | KIAH OCKERBY | RD16 | TBA | RD23 | TBA |
| J4 | EZYSTRUT | RD10 | JULIAN NISBET | RD17 | TBA | RD24 | TBA |
| RD04 | MANDY MOFFITT | RD11 | TBA | RD18 | TBA | RD25 | TBA |
| RD05 | MANDY MOFFITT | RD12 | TBA | RD19 | TBA | RD26 | TBA |
| RD06 | TODD HUGHES MANDY MOFFITT | RD13 | TBA | RD20 | TBA | WIN | TBA |

| | | | | | | | | | | | | | |
|-----|------------------------------|---|---|----|---|---|----|---|----|----|---|---|----|
| KNI | DONNA BURTON | J | 2 | 3 | 6 | 4 | 12 | 5 | 5 | 6 | 4 | 5 | 52 |
| KNI | DUSTY BARNES | J | 1 | 7 | 7 | 1 | 6 | 4 | 5 | 7 | 7 | 7 | 52 |
| DRA | GRANT HETHERINGTON |  J | 4 | 5 | 3 | 4 | 4 | 4 | 10 | 6 | 6 | 6 | 52 |
| STO | PHIL HANSEN |  J | 1 | 10 | 4 | 5 | 5 | 5 | 5 | 6 | 6 | 5 | 52 |
| DOG | JAMES BUCKLEY |   J | 1 | 6 | 7 | 4 | 6 | 3 | 6 | 5 | 8 | 6 | 52 |
| TBA | JARREN BULL | J | 5 | 7 | 7 | 3 | 6 | 4 | 6 | 4 | 4 | 6 | 52 |
| KNI | JOE ROSS |  J | 4 | 7 | 5 | 6 | 5 | 3 | 5 | 6 | 5 | 6 | 52 |
| SHA | JOEL PURCELL |  J | 4 | 6 | 7 | 4 | 6 | 4 | 5 | 6 | 4 | 6 | 52 |
| SHA | DARREN KEMP |  J | 5 | 7 | 3 | 6 | 6 | 6 | 6 | 6 | 4 | 3 | 52 |
| EAG | NATHAN BURNS | J | 3 | 6 | 6 | 4 | 7 | 4 | 7 | 6 | 4 | 5 | 52 |
| ELS | JESUS WILLIAMSON |  J | 3 | 6 | 7 | 5 | 4 | 5 | 6 | 6 | 5 | 5 | 52 |
| RAI | RYAN GUIHOT |  J | 3 | 7 | 5 | 5 | 5 | 4 | 6 | 6 | 5 | 6 | 52 |
| EAG | PACKMAN |  J | 2 | 7 | 5 | 3 | 6 | 4 | 5 | 6 | 8 | 5 | 51 |
| TBA | ALLYSON JONES (L&C) | J | 4 | 6 | 7 | 4 | 6 | 4 | 5 | 6 | 4 | 5 | 51 |
| PAN | CAMERON MASSEY |  J | 2 | 6 | 7 | 5 | 6 | 4 | 4 | 6 | 5 | 6 | 51 |
| SHA | CRAIG "CAR2" SHULTZ |  J | 2 | 7 | 5 | 5 | 5 | 5 | 5 | 6 | 4 | 7 | 51 |
| KNI | GAVIN NOFFKE | J | 4 | 10 | 6 | 2 | 6 | 4 | 4 | 5 | 4 | 6 | 51 |
| 9th | KANE CONNOLLY |  J | 4 | 7 | 4 | 4 | 4 | 4 | 4 | 12 | 3 | 5 | 51 |
| BRO | LEIGH KENNY |  J | 3 | 10 | 3 | 4 | 6 | 4 | 4 | 6 | 4 | 7 | 51 |
| DRA | NEIL WILSON |  J | 1 | 7 | 5 | 5 | 5 | 7 | 6 | 7 | 4 | 4 | 51 |
| RAI | PAUL ABRA | J | 5 | 6 | 5 | 3 | 6 | 5 | 4 | 4 | 8 | 5 | 51 |
| RAB | SHANNON "BIG" FARHKDVAN |  J | 6 | 5 | 5 | 3 | 5 | 4 | 5 | 6 | 5 | 7 | 51 |
| STO | ZACH CULL |  J | 2 | 12 | 4 | 3 | 4 | 4 | 5 | 5 | 5 | 7 | 51 |
| KNI | CAMERON CHAFFEY | J | 4 | 6 | 6 | 4 | 6 | 4 | 5 | 4 | 5 | 6 | 50 |
| KNI | COLIN O'BRIEN |   J | 3 | 7 | 5 | 5 | 6 | 4 | 5 | 7 | 4 | 4 | 50 |
| SHA | CORINNA HAMILTON (EZYSTRUT) | J | 2 | 7 | 4 | 4 | 6 | 4 | 7 | 5 | 5 | 6 | 50 |
| TIG | RYAN CORRIGAN | J | 2 | 5 | 3 | 5 | 5 | 4 | 5 | 10 | 5 | 6 | 50 |
| DRA | CRAIG CAPP |  J | 4 | 6 | 4 | 7 | 5 | 5 | 6 | 5 | 3 | 5 | 50 |
| EAG | ANDREW DIGBY | J | 4 | 7 | 4 | 4 | 5 | 5 | 5 | 6 | 4 | 6 | 50 |
| SHA | GAVIN FARHAM |  J | 2 | 6 | 5 | 3 | 4 | 6 | 7 | 4 | 6 | 7 | 50 |
| TBA | GERALD "MANYNAMES" BAGATELLA |  J | 2 | 6 | 6 | 5 | 6 | 3 | 6 | 5 | 6 | 5 | 50 |
| ELS | GLEN HODGES |   J | 5 | 5 | 6 | 4 | 3 | 5 | 6 | 4 | 6 | 6 | 50 |

| | | | | | | | | | | | | | | | | | | | | | | |
|------------|---|---|---|---|---|---|---|---|---|---|---|---|--|--|--|--|--|--|--|--|--|-----------|
| PAN | TOM PALMER | J | 1 | 6 | 2 | 6 | 3 | 3 | 3 | 5 | 5 | 4 | | | | | | | | | | 38 |
| TIG | NEIL ELFORD  | J | 2 | 5 | 3 | 3 | 5 | 5 | 4 | 1 | 3 | 5 | | | | | | | | | | 36 |
| ROS | LIANNA BLOCK | J | 6 | 3 | 4 | 4 | 2 | 3 | 3 | 3 | 4 | 3 | | | | | | | | | | 35 |
| TIG | TOM TURNBULL | J | 5 | 3 | 2 | 3 | 2 | 3 | 5 | 5 | 3 | 3 | | | | | | | | | | 34 |
| na | WHITEY -2 pts (did you forget your tips...?) | J | 2 | 3 | 2 | 3 | 2 | 3 | 5 | 4 | 3 | 3 | | | | | | | | | | 30 |
| na | AWAY TEAMS | J | 4 | 0 | 1 | 3 | 1 | 3 | 3 | 6 | 5 | 3 | | | | | | | | | | 29 |
| | | | | | | | | | | | | | | | | | | | | | | |

In loving memory of Ross & Sandra Joice



RULES:

- 1 point for correct pick.
- 2 bonus points if you pick all games in the round correctly (Perfect Round).
- Double points for your JOKER round (you only get 1x JOKER Round).
- No tips handed in results in MY (Mark) score for that round -2pt.



LEGEND:

-  JOKER round taken
-  Tips not sent in ...
-  Table Leader ...
-  Perfect Round ...

SPECIAL ATTRIBUTES:

-  Previous Winner ...
-  Previous Runner-up ...
-  Last Years Wooden Spoon

SERVICE ATTRIBUTES:

-  RJAN Tipping Comp Original ...
-  10 Year Veteran ...
-  5 Year Veteran ...